

The handle connecting rod material you can choose stainless steel, or plastic materials

# PV Surge Protector

## Lightning and surge protection for PV systems installed on buildings

Please take the following measures to protect the PV system from damage of lightning impulse or surge voltage:

- All metal parts (such as framework, support, etc) of PV system must be connected to the main equipotential bus to ensure reliable equipotential connection of the whole system.
- Must keep a safe distance (S) between all parts of PV systems and the external lightning protection system. The external lightning protection system can be connected to the main equipotential bus, fundamental earth screen or ground ring only.
- Adoption of twisted-pair wiring to reduce system jamming.
- For cables from outdoors, the surge protection device should be installed at the entrance of buildings. An all-round and systematic lightning protection should also protect other facilities on buildings from being damaged.

Reasonable wiring:

adoption of twisted-pair wiring with lines as short as possible, to avoid big loop and reduce induced voltage on circuits.

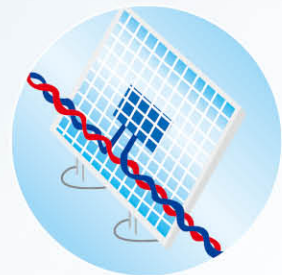

Surge protection device installed on the DC side:

for cables from outdoors, the surge protection device should be installed at the entrance of buildings.

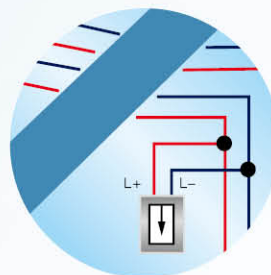

safe distance (S):

must keep a safe distance between all parts of PV systems and the external lightning protection system.

PV modules installed in the lightning protection zone:

all solar panels must be installed in the lightning protection zone OB to protect equipment from direct lightning strike. (Refer to IEC/EN62305-3:2006 lightning protection zone)

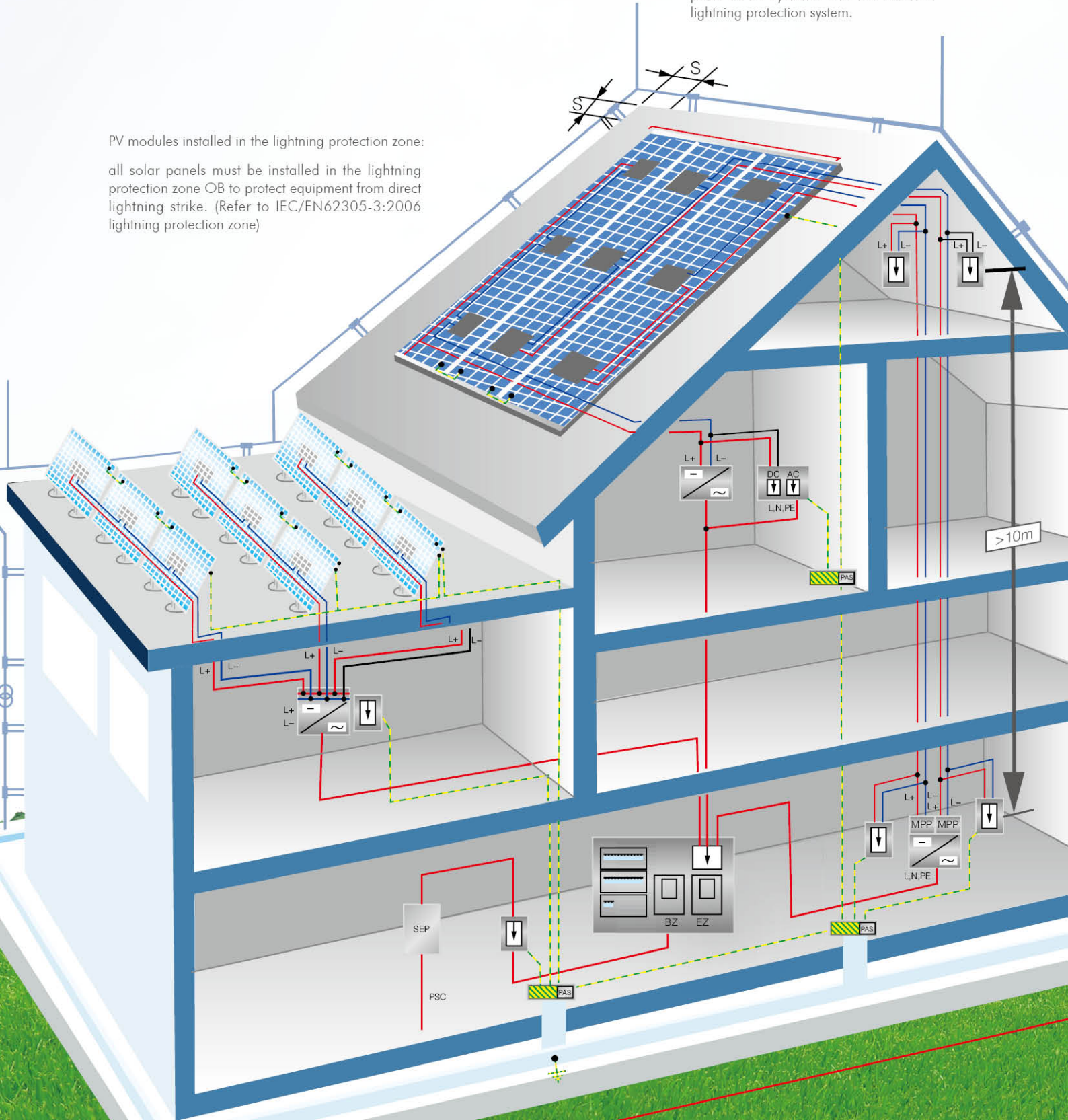

## SUP2-PV Series Surge Protector



### Specifications



SUP2-PV surge protective device, protect against lightning surge voltages in solar system (photovoltaic power supply system).

These units must be installed in parallel on the DC networks to be protected and provide common and different modes protection. Its installed location are recommended at both ends of the DC power supply line (solar panel side and inverter/converter side), ely if the line routing is external and long.

High energy MOVs equipped with specific thermal disconnectors and related failure indicators.

SUP2-PV series surge protector		SUP2-PV	
PV DC-specific (LEC 66143-1/EN 61643-11)			
Pole		2P	3P
Electrical Parameter			
Classified test		II	II
Uoc max (V DC)		500	900
Uc (V DC)		500	1000
In(8/20)us (kA)		20	20
Imax(8/20)us (kA)		40	40
Up (kV)		2.0	3.8
Remote control and indication			
Indication window			
Plug-in Module			
Remote signal contact			
Remote signal contact	maximum working voltage(V)	250 AC/30V DC	250AC/30V DC
	maximum working current (A) 1A(250V/ AC)	1A(250V/ AC)	1A(250V/ AC)
	1A (30V DC)	1A(30V/ AC)	1A(30V/ AC)
Wiring & installation			
Wiring capacity(mm <sup>2</sup> )	Hard wire	4~25	4~25
	Flexible wire	4~16	4~16
Stripping length(mm)		10	10
Terminal screw		M5	M5
Torque(Nm)	Main circuit	3.5	3.5
	Remote signal contact	0.25	0.25
Protection class	All profile	IP40	IP40
	Connection port	IP20	IP20
Installation environment		No obvious shock and vibration	
Altitude (m)		≤2000	≤2000
Working Temperature		-3.0~+70	-3.0~+70
Relative humidity		30%~90%	30%~90%
How to Install		Installed with H35-7.5/DIN35 steel mounting rail	
Size(mm)(WxHxL)	W	36	54
	H	90	90
	L	67.6	67.6
Weight (kg)		0.24	0.36

## SUP4-PV Photovoltaic Surge Protective Device



Visual Status Indication



Remote Signal Contact Available



The Cooper suntree three-module photovoltaic Surge Protective Device (SPD) (with three-step DC switching device) features visual indication and optional remote contact signaling (floating changeover contact) for use in PV systems. These complete surge protective devices are suitable for all PV systems in accordance with IEC 60364-7-712. Includes a five year limited warranty.

These prewired solutions consist of a base and locking modules that feature a combined disconnection and short-circuiting (shunting) device with safe electrical isolation to prevent fire damage due to DC arcs. An integrated DC fuse allows safe module replacement without arc formation.

In case of insulation faults in the generator circuit, a reliable and tested fault-resistant Y circuit prevents damage to the surge protective devices.

The green and red visual indicator flags show the module protective status (green = good, red = replace). Apart from this visual indication, the remote signaling option features a three terminal floating changeover contact that can be used as a make or break contact depending on the particular monitoring system design employed.



### Dimensions(mm)

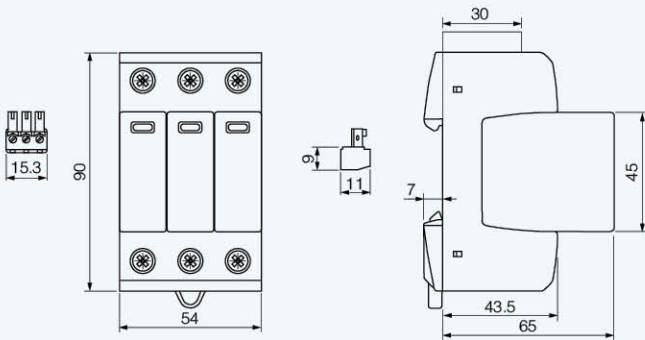

### Module Circuit Diagrams

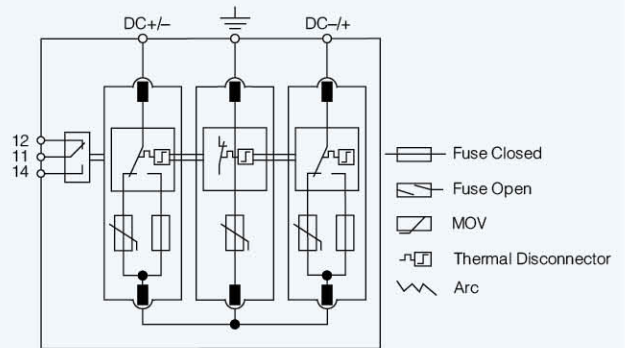

### Short-Circuit Interrupting (SCI) Technology

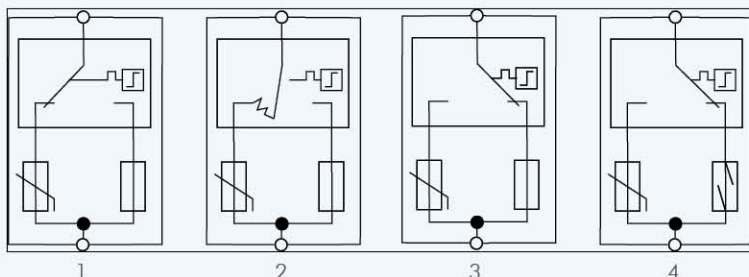

1. Original State
2. Disconnection Device Response
3. Arc Extinguishes
4. Safe Electrical Isolation

### Specifications

Nominal PV System Voltage	600V	1000V	1200V
MCOV [UCPV]	700Vdc	1170Vdc	1200Vdc
Max System Discharge Current (8/20 μs) [Imax]	40kA	40kA	30kA
Voltage Protection Level [UP]	≤2.5kV	≤4.0kV	≤4.5kV
Voltage Protection Level at 5kA [UP]	≤2.0kV	≤3.5kV	≤4.0kV
Integrated Fuse Breaking Capacity/Interrupting Rating	30kA/1000Vdc	30kA/1000Vdc	30kA/1200Vdc
Technology	Short-Circuit Interruption (SCI) Overcurrent Protection		
Operating Temperature Range [TU]	-40°C to +80°C		
Nominal Discharge Current (8/20 μs) [(DC+/DC-) --> PE] [In]	12.5kA		
Response Time [tA]	<25ns		
Operating State/Fault Indication	Green (good)/Red (replace)		
Conductor Ratings and Cross-Sectional Area:	Minimum	60/75°C 1.5mm <sup>2</sup> /14AWG Solid/Flexible	
	Maximum	60/75°C 35mm <sup>2</sup> /2AWG Stranded/25mm <sup>2</sup> /4AWG Flexible	
Mounting	35mm DIN Rail per EN 60715		
Enclosure Material	UL 94V0 Thermoplastic		
Degree of Protection	IP20		
Capacity	3 Modules, DIN 43880		
Standards Information:	IEC 61643-11 Type 2, IEC 61643-1 Class II		
Product Warranty	Five Years**		

### Remote Contact Signaling

Remote Contact Signaling Type	Changeover Contact
AC Switching Capacity (Volts/Amps)	250V/0.1A
DC Switching Capacity (Volts/Amps)	250V/0.1A; 125V/0.2A; 75V/0.5A
Conductor Ratings and Cross-Sectional Area for Remote Contact Signal Terminals	60/75°C Max. 1.5mm <sup>2</sup> /14AWG Solid/Flexible
Ordering Information	Order from Catalog Numbers Above

### Typical Application Schematics

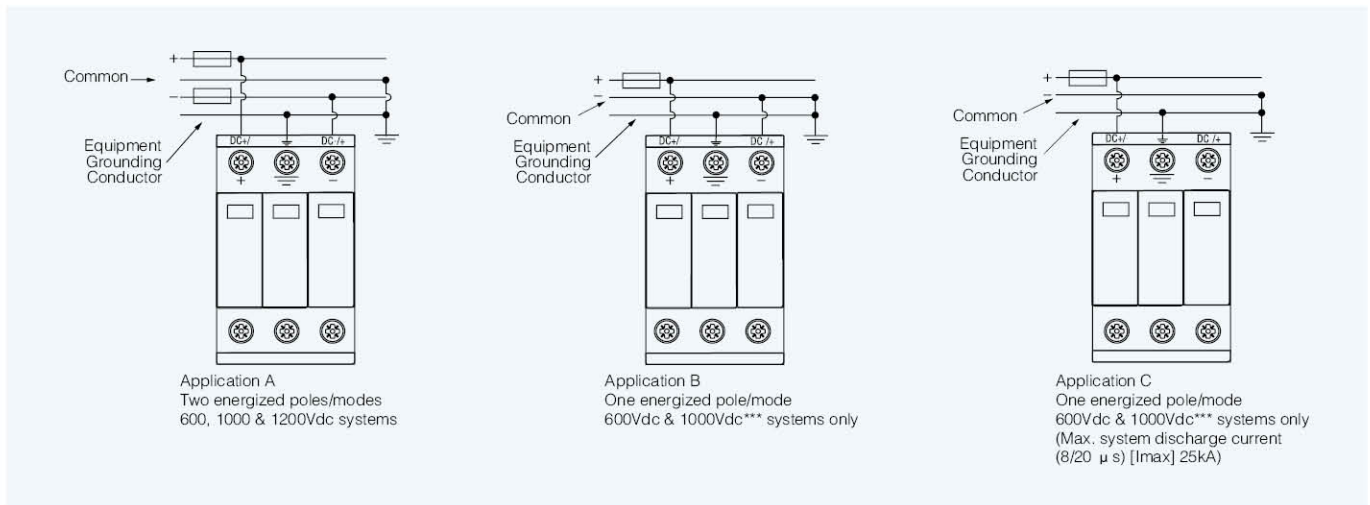

\* Does not apply to 1200Vdc.

1. Use a suitable electrical insulator to keep a 10mm min. safety distance from the PV-SPD and other grounded parts in the housing.
2. No metal covers are in the area of the module release buttons as shown.

## Conductors and Busbars for Use in Photovoltaic Systems

IEC 60364-7-712 (DIN VDE 0100 Part 712)

60/75°C Cu Conductors		
Min. □ DC±, DC±, ↓	1.5mm <sup>2</sup> /14AWG	
Max. □ DC±, DC±, ↓	25mm <sup>2</sup> /4AWG	35mm <sup>2</sup> /2AWG
Busbar	16mm <sup>2</sup> Cu  ≥ 15.5mm	

### Visual Indication Status

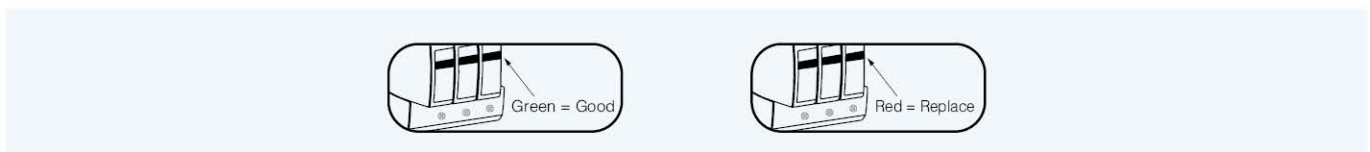

### Fault Indication & Remote Contact Signaling (with modules installed)

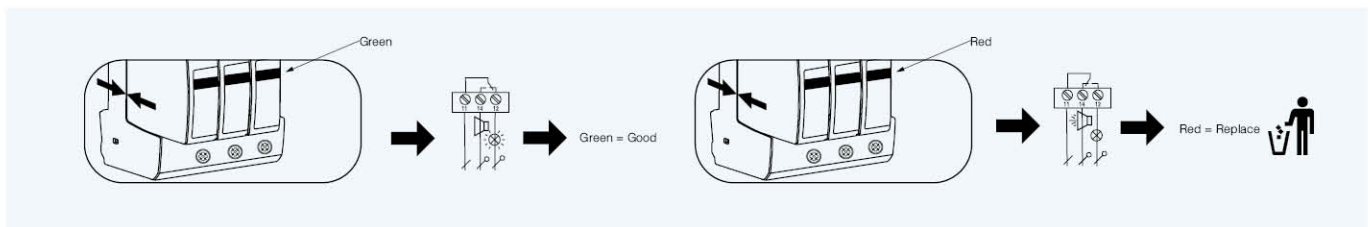

### Testing Remote Contact Signaling (with modules removed)

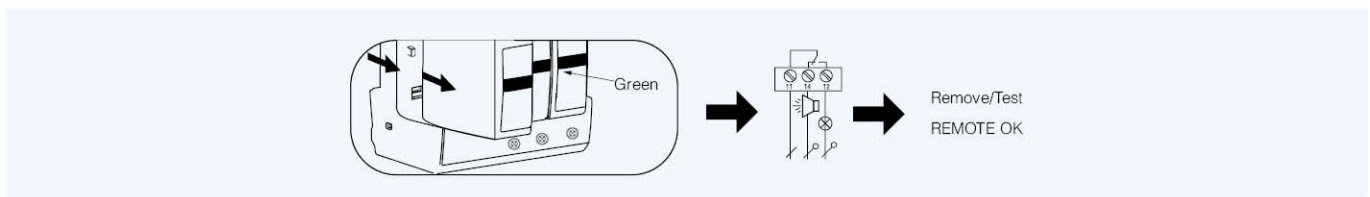

### Remote Contact Signaling

